



Spare Parts for  
Pharmaceutical  
Machines

# FILL-FINISH COMPONENTS PORTFOLIO

## Aseptconn AG

Aseptconn is a leading component supplier for the sterile liquid technology used in the pharmaceutical and biopharmaceutical industries. Our innovative products in combination with our years of pharma experience, and resultant expert guidance, enhance the productivity and safety of our customers' manufacturing processes in a sustainable way.

A benefit of our extensive experience is a stock and certification management system that guarantees short delivery with complete, correct, and traceable certification documentation for each order. In addition, our wide range of products allows our customers' to obtain all components from a single source.



ASEPTCONN AG  
*Bulle, Switzerland*



## **Aseptconn Team**

Created in 2016, Aseptconn is made up of a team with many years of experience in the consulting and sale of components for sterile process technology. We are a customer centric organization focused on innovation, responsiveness and complete order satisfaction. These values provide the foundation for our business conduct.

### **Aseptconn is ISO 9001:2015 certified.**

When you choose Aseptconn, you choose excellence, innovation and a good partnership. We are proud to contribute to the long-term success of our customers' by offering them solutions that make the difference. We consider quality, service, flexibility, and customized solutions to be of uppermost importance.



**Fabio Stiz**  
CEO & Co-Founder

**Welcome**

Trust thanks to great  
expertise and many  
years of experience

ASEPTCONN AG

**// High expectations are  
principle to success in  
business //**



---

## Introduction

### Who We Are

**Business:** Together

Fill-finish spare parts are very important components in the pharmaceutical liquid productions. It is often difficult for outsiders to comprehend the complexity of choosing the right solutions in this context.

The multitude of applications standard and not-standard, the features of the materials used, or the numerous options make the configuration of the fill-finish systems a true art.

Although numerous companies are entering this demanding market, only a handful have really established themselves. We are all the more proud of the great success of Aseptconn in this market environment. But this success does not come by chance. Our employees have the required specialist knowledge and many years of experience in the technical sales and manufacturing of such fill-finish components.





**Sergio Cerenzia**  
COO & Co-Founder

### Welcome

The leading solution for  
liquid sterile technology

ASEPTCONN AG



**The ability to innovate  
with high knowledge of  
the sterile environment**



## Introduction

### Who We Are

**Business:** Together

This special expertise has been incorporated into the design and manufacture of high precision fill-finish components for pharmaceutical liquids. The ability to innovate with high knowledge of the sterile environment make it possible for Aseptconn to provide customized solutions to each problem and offer technical answers to the requirements of our customers'.

You will find numerous other examples in our fill-finish portfolio that demonstrate why you can trust Aseptconn when it comes to selecting the right components. We look forward to being able to provide you with support and advice.

Warm regards,  
Fabio Stiz & Sergio Cerenzia

# NEEDLES

FOR STERILE AND ASEPTIC PROCESSES



# Contents

	Page No.
<b>Our Mission, Vision &amp; Values</b> The Leading Solution for Liquid Sterile Technology	<b>10</b>
<b>Certifications</b> The Leading Solution for Liquid Sterile Technology	<b>13</b>
<b>Engineering &amp; Design</b> The Leading Solution for Liquid Sterile Technology	<b>14</b>
<b>Materials &amp; Finishing</b> Manufacturing Excellence	<b>16</b>
<b>Multi-Use Solutions</b> Manufacturing Excellence	<b>18</b>
<b>Filling Needles</b> Manufacturing Excellence	<b>19</b>
<b>Multi-Use Filling Needles</b> Manufacturing Excellence	<b>22</b>
<b>Single-Use Filling Needles</b> Manufacturing Excellence	<b>31</b>
<b>Needle Tips</b> Manufacturing Excellence	<b>32</b>
<b>Filling + Gassing Needles</b> Manufacturing Excellence	<b>33</b>



<b>Gassing Needles</b> Manufacturing Excellence	<b>37</b>
<b>Washing Needles</b> Manufacturing Excellence	<b>42</b>
<b>Blowing &amp; Suction Needles</b> Manufacturing Excellence	<b>46</b>
<b>Stopper Guide Tubes</b> Manufacturing Excellence	<b>48</b>
<b>Connections</b> Manufacturing Excellence	<b>51</b>
<b>Manifolds &amp; Tanks</b> Manufacturing Excellence	<b>54</b>
<b>Format Parts</b> Manufacturing Excellence	<b>60</b>
<b>Accessories</b> Manufacturing Excellence	<b>68</b>
<b>Order Process</b> Connect with Aseptconn	<b>70</b>
<b>Your Contacts</b> Connect with Aseptconn	<b>71</b>

## WELCOME TO ASEPTCONN

//  
YOUR PARTNER FOR  
STERILE AND  
ASEPTIC PROCESSES  
//

Your preferred partner for components, systems, software, and services in the field of liquid sterile technology and transfer solutions. With our mission, vision, and values, we passionately support the pharmaceutical, biopharmaceutical and other critical industries.

# OUR MISSION

THE LEADING SOLUTION FOR LIQUID STERILE TECHNOLOGY



Our mission is to respond quickly and efficiently to the needs of our customers. We are also committed to driving innovation in the pharmaceutical and biotech sectors by offering new tools adapted to the needs of all our partners. Our Mission is to ensure long service life, reliability, and perfection in every one of our products. We can find the correct solutions to your needs; we support our customers and provide them with the best service. Our responses and deliveries are fast and reliable.

# OUR VISION & VALUES

## THE LEADING SOLUTION FOR LIQUID STERILE TECHNOLOGY

Our vision is to become the leading provider of fluid transfer components and products in several european countries and worldwide. By supporting well-known pharmaceutical companies, we are building a strong and lasting presence, both in our home markets and abroad. We believe in the power of collaboration to achieve common goals, with our large stock of products and components we guarantee fast delivery worldwide. We consider quality, service, flexibility, and customized solutions to be of uppermost importance.

**We are committed to embodying core values that guide our daily work:**



### Expertise and LEADERSHIP

With our recognized expertise, we strive for leadership in our field of activity.



### Excellence and QUALITY

We strive for excellence and guarantee products and services of the highest quality.



### Engagement and TOP SERVICE

We are committed to delivering exceptional quality solutions to satisfy all of our customers.



### Flexibility and RESPONSIVENESS

We adapt quickly to the changing needs of the market and the requirements of our customers'.

# CERTIFICATIONS

## THE LEADING SOLUTION FOR LIQUID STERILE TECHNOLOGY

Aseptconn is in line with food & pharma regulations compliant, tubes, materials coming from Swiss steelworks and manufacturers MOCA or FDA certified, ensuring maximum quality of products thanks to strict controls on raw materials. On delivery, we check and cross reference each raw material bar to the corresponding certificate number. When the material is cut, the certificate number is linked to the workpiece, achieving in this way a real traceability for each component of our products. The final product must meet the highest quality standards monitored with appropriate measuring equipment. Products certifications include the tests reports carried out. We consider quality and transparency of primary importance: for this reason, we regularly test the materials and coatings of our products independent.

**All the fill-finish components are in line with GMP and FDA standards and supplied with the complete 3.1 certification according to EN 10204.**

# WE DESIGN YOUR CUSTOMIZED PROJECTS

Aseptconn engineering's design team has the best specialists for your new project, we can provide designs quickly and accurately. Any adjustments can be done to existing drawings, or a new drawing can be developed.

Each project can be finalized from the start of the design till the final installation. We are able to re-design and improve parts of existing systems, to achieve the best results based on the feedback of our customers'. The final products are complete with surface treatments as well as special coatings. Components are laser marked on customer's request.

Aseptconn offers a comprehensive service, support, and technical advice from design to final installation. We can deliver custom-made designs; our design engineers will support you with the first step in inventorying the process correctly.

# ENGINEERING & DESIGN

## THE LEADING SOLUTION FOR LIQUID STERILE TECHNOLOGY

A highly skilled team of designers can develop customized projects starting from the specifications of the pharmaceutical machine or from the characteristics of the liquid to be dosed. We can optimize the product design and give advice for improvement. We ensure customer-focused advice, analysing each problem and propose customized solutions to optimise the performance of the entire production line. We aim for tailored solutions designed to meet our customers' needs and requirements.

Aseptconn is your most reliable, knowledgeable partner that can provide the technical support to find the best solutions. Every phase of research, development, and manufacturing is done with high purity process solutions. Our products ensure uncompromising quality finishing, synonymous with the highest quality.



# MATERIALS

## MANUFACTURING EXCELLENCE

Aseptconn components are manufactured with 316L Stainless Steel, Titanium, Hastelloy C-22 or plastic materials such as Peek, PTFE, Pom-C, Polycarbonate, Polypropylene approved by FDA and USP Class VI. All the components are made from a single block or laser/TIG welded without death zones. The internal surface of the tubes is  $RA < 0.5 \mu m$  and provided with a roughness test report.

**We provide all traceability documents of materials in full conformity with UNI EN 10204 3.1 / FDA / USP Class VI.**

316L STAINLESS STEEL



PEEK PLASTIC



HASTELLOY







# FINISHING

## MANUFACTURING EXCELLENCE

Aseptconn components have a polished surface and a complete decontamination and passivation. Ultrasonic washing and final cleaning in conformity with NSF and FDA standards for food and pharmaceutical processing. Process contact surfaces shall be finished using mechanical or electropolishing. A multiple step cycle process is conducted to ensure surfaces quality with consistent repeatability:

1. **Degreasing**
2. **Pickling**
3. **Passivation**
4. **De-ionized water cleaning**

# MULTI-USE SOLUTIONS

## MANUFACTURING EXCELLENCE

Aseptconn is specializing in designing and manufacturing top quality and accurate dosing systems that are 100% Swiss made. We achieve the highest standards of precision for dosing all kinds of pharmaceutical substances, a technologically advanced workshop and constant innovation in design. Aseptconn fill-finish components are designed made-to-measure, our custom-made service provides the best technical advice for any kind of customers requirements. We provide a wide range of solutions, accessories, and components for all types of sterile and aseptic operations. We can develop components for every pharmaceutical machinery starting from a sample or an initial drawing according to the technical specifications provided by our customers'. Aseptconn can repair old or damaged components which is significant cost saving for the customer.



# FILLING NEEDLES

## MANUFACTURING EXCELLENCE

### Definition and Application Areas of Filling Needles in the Industry

Filling needles are specially designed instruments used in various industries to precisely dose liquids or semi-liquid products and fill them into containers, ampoules, or other packaging. These needles are more than simple channels, they often result from advanced engineering and material science to meet the specific requirements and standards of each industry. Here are some of the key application areas:

#### BIOTECH & PHARMA



#### COSMETICS



#### CHEMICALS



#### FOOD & BEVERAGE



//  
WE ARE DRIVEN BY EXPERTISE  
THAT DELIVER  
HIGH QUALITY PRODUCTS  
//

# HIGH FILLING PRECISION FOR STERILE AND ASEPTIC PROCESSES

## Filling Needles

In specialized fields such as biotechnology, pharmaceuticals, cosmetics, chemicals, and food production, the reliability of every individual process step is paramount. Within this framework, filling needles play a pivotal role. Their precise design and execution ensure consistent filling while simultaneously safeguarding the quality and integrity of the end product.

This section sheds light on the technical specifications and requirements of filling needles, emphasizes their central role in highly specialized industrial processes, and provides a guide on what to consider when acquiring these critical instruments. Filling needles, despite their apparent simplicity, are an integral part of many industrial processes. Their ability to dose liquids with high accuracy and consistency makes them an indispensable tool in a variety of industries.

# NEEDLES SELECTION

## MANUFACTURING EXCELLENCE

### FEATURES OF HIGH-QUALITY NEEDLES SELECTION CRITERIA WHEN PURCHASING

Choosing the right needles is crucial for the success of your pharmaceutical, biotechnological, or other critical processes. Aseptconn is your preferred partner for high-quality needles and other components that contribute to improving your processes. Our products are the result of innovation, quality, and years of industry experience.

Our design team can develop components for any pharmaceutical machine, starting from a sample or initial drawing according to our customers technical specifications. At first glance, a needle may appear to be a simple tool, but there are critical details in its design and manufacturing that determine its efficiency and reliability. By examining the following features, you can identify the right needle for your production:

**Multi-Use:** Our multi-use needles need to be cleaned before use. However, since they can be reused several times before replacement, they offer short-term cost savings. Stainless steel needles provide a wide range of filling options that can eliminate issues like foaming or dripping. They can also be tailored to specific needs.

**Single-Use:** These needles do not require cleaning before use, which extends manufacturing time and reduces processing and cleaning times. Furthermore, they are self-cleaning, gamma-irradiated, and delivered in double packaging to ensure sterility. Single-use needles eliminate the risk of cross-contamination with other components since they are used only once.

# MULTI-USE NEEDLES

## MANUFACTURING EXCELLENCE

Filling Needles are applicable for every pharmaceutical machine and designed for every liquid, volume, and viscosity to fill with accuracy the correct dose of the liquid from 0.005 up to 250 ML with volumetric or peristaltic fill- finish systems.

Aseptconn Needles can replace all the OEM fill-finish needles suitable for the main brands of machines such as Bausch Stroebel, Syntegon, IMA, Groninger, Marchesini, Rota, Optima, Romaco, Steriline machinery and more. The needles are designed for every liquid, volume and viscosity and can be repaired like new.



## FEATURES OF HIGH-QUALITY NEEDLES SELECTION CRITERIA WHEN PURCHASING

**Material Quality:** The material from which the needle is made plays a crucial role. For example, stainless steel is often the preferred choice in the pharmaceutical and food industries due to its durability, corrosion resistance, and sterility.

**Precision:** A needle must be able to dose liquids or other substances in a precisely defined quantities. The design of the tip and the diameter of the needle determine how accurately and uniformly the substance is dispensed.

**Compatibility:** The needle should be compatible with the machines and fill-finish systems used in the respective industry. Good adaptability ensures seamless integration into existing production lines.

**Ease of Cleaning:** An easily cleanable needle minimizes the risk of contamination and ensures high product quality. In industries such as pharmaceuticals or food production, this can be crucial.

**Robustness:** The needle should be resistant to mechanical stresses, high temperatures, and chemical influences. This ensures a long service life and prevents frequent failures or replacements.

**Certifications:** Especially in regulated industries, needle should comply with relevant standards and certifications. Such certificates guarantee that the product has undergone strict quality and safety checks and ensure operational safety.

\* When acquiring a needle, it is essential to consider not only the price but, more importantly, the criteria mentioned above. Careful selection guarantees not only efficient production but also the safety and quality of the end product.

Multi-Use - FILLING NEEDLES



SS316L

Filling Needle for B+S Ampoules Machines



SS316L

Filling Needle with Anti-Drip Tip for B+S Ampoules Machines



Multi-Use - FILLING NEEDLES



SS316L & PEEK NUT

PTFE Connection Filling Needle for B+S Vials Machines



SS316L

Filling Needle with Anti-Drip Tip for Watson Marlow Peristaltic Pump





## Multi-Use - FILLING NEEDLES



SS316L

Filling Needle with Flattened Tip for  
Dara Pharma Vials Machines



SS316L

Filling Needle for Dara Pharma  
Syringes Machines



## Multi-Use - FILLING NEEDLES



SS316L

Filling Needle for Groninger Syringes  
Machines



SS316L

Filling Needle for Groninger Sterile  
Filler Machines



Multi-Use - FILLING NEEDLES



SS316L

Filling Needle with Anti-Drip Tip  
for MAR Vials Machines



SS316L

Filling Needle for Optima Inova  
Vials Machines



Multi-Use - FILLING NEEDLES



SS316L

Filling Needle with Anti-Drip Tip  
for Marchesini Ampoules Machines



SS316L & PEEK NUT

PTFE Hose Connection Filling Needle  
for Marchesini Vials Machines



Multi-Use - FILLING NEEDLES



SS316L

Silicone Hose Connection Needle for IMA Farmomac Vials Machines



SS316L

PTFE Hose Connection Filling Needle for IMA Farmomac Aseptic Machines



Multi-Use - FILLING NEEDLES



SS316L

Filling Needle with Anti-Drip Tip for IMA Pharma Ampoules Machines



SS316L

Needle with Anti-Foam Scoop Tip for IMA Pharma Ampoules Machines



Multi-Use - FILLING NEEDLES



SS316L

Needle with Anti-Foam Scoop Tip  
for Syntegon Bosch Vials Machines



SS316L

Filling Needle with Anti-Drip Tip  
for Syntegon Bosch Vials Machines



Multi-Use - FILLING NEEDLES



SS316L

Filling Needle for Syntegon Bosch  
Syringes Machines



SS316L

Filling Needle for Syntegon Bosch  
Syringes Machines



---

## Multi-Use - FILLING NEEDLES



SS316L

Filling Needle with Anti-Drip Tip  
for Rota Ampoules Machines



SS316L

Filling Needle for Rota Ampoules  
Machines



---

## Multi-Use - FILLING NEEDLES



SS316L

Filling Needle for Steriline SFM  
Vials Machines



SS316L

Filling Needle for Steriline SFM  
Vials Machines



Multi-Use - FILLING NEEDLES



**Peek needles:**

Peek needle are autoclavable and suitable for sterile or aseptic environments with acid-corrosives substances. The needles can be used like disposable or multi-use. Aseptconn can provide pre-sterilized needles packaged in double bag and assembled with silicone or PTFE hoses. The benefits of this solutions are many: metal ion-free filling, suitable for warm liquids, high chemical stability, low weight and good cleanability.

SS316L

Filling Needle for Truiking Syringes  
Machines



Multi-Use - Disposable - FILLING NEEDLES



PEEK

Acid-Proof Peek Plastic Filling  
Needle for Truiking Vials Machines



PEEK

Acid-Proof Peek Plastic Filling Needle  
for Syntegon Bosch Vials Machines



# SINGLE-USE NEEDLES

## MANUFACTURING EXCELLENCE

These needles do not require cleaning before use, which extends manufacturing time and reduces processing and cleaning times. Furthermore, they are self-cleaning, gamma-irradiated, and delivered in double packaging to ensure sterility. Single-use needles eliminate the risk of cross-contamination with other components since they are used only once.

SELF-CLEANING



GAMMA-IRRADIATED



NO CROSS-CONTAMINATION



DOUBLE PACKAGING



## Single-Use - Needles



SS316L & PEEK

Disposable Filling Needle for Groninger  
Aseptic Filler Machines

For orders or request scan the QR  
code or go to [www.aseptconn.ch](http://www.aseptconn.ch)



# NEEDLE TIPS

## MANUFACTURING EXCELLENCE

The needles may be partly responsible in some cases for filling problems such as foam, dripping, splash, liquid that overflows. We have already treated many problems and we can optimize many parts of the needle to limit or to remove the aspects that disrupted the filling. It should be noted that the needle represents only a small part of filling problems, in most of cases it is often necessary to look at other aspects of the filling line for example cadence, dosed product, installation. To find the origin we have the best technical expert who can intervene on your installations to analyze the situation and allow you to solve the malfunctions. Customized needle tips are developed to fix or reduce the common filling problems and can be produced for every needle.



**ANTI-DRIP**

*BASKET 30 TIP*



**ANTI-FOAM**

*SCOOP TIP*



**FLATTENED**

*TIP*



**CONICAL**

*TIP*



**RESTRICTION**

*TIP*



**BEVEL**

*TIP*



# FILLING + GASSING NEEDLES

## MANUFACTURING EXCELLENCE

Our laser welded filling + gassing needles are designed to optimize the nitrogen diffusion inside vials, ampoules and syringes. Laser marking - permanent identification with complete traceability of lot number. Their RA < 0.5  $\mu\text{m}$  guarantees maximum sterilisation and hygiene standards. Respect for good manufacturing processes: GMP, passivated and decontaminated.

**Co-Axial Nitrogen + Filling Needles Tips:** are developed to optimize the gas diffusion inside the pharmaceutical container and fix or reduce the main filling problem. Customized needle tips can be developed by our engineering's design team and can be produced for every needle. Our expert guidance and customer support can provide the best solutions to optimize many parts of the needle to limit or to remove the aspects that disrupted the filling + gassing process. Aseptconn Customized needle tips are developed for every needle.



Multi-Use - FILLING + GASSING NEEDLES



SS316L

Nitrogen + Filling Needle for  
Dara Pharma Syringe Machines



SS316L

Gassing + Filling Needle for  
Groninger Aseptic Machines



Multi-Use - FILLING + GASSING NEEDLES



SS316L

Gassing + Filling Needle for IMA  
Pharma Ampoules Machines



SS316L

Gassing + Filling Needle for  
MAR Sterile Machines



## Multi-Use - FILLING + GASSING NEEDLES



SS316L

Nitrogen + Filling Needle for  
B+S Syringe Machines



SS316L

Gassing + Filling Needle for  
B+S Syringe Machines



## Multi-Use - FILLING + GASSING NEEDLES



SS316L

Gassing + Filling Needle for  
B+S Aseptic Machines



4 SPLITS GASSING TUBE

FLAT FILLING + GASSING TIP

Multi-Use - FILLING + GASSING NEEDLES



SS316L

Nitrogen + Filling Needle for  
Marchesini Ampoules Machines



3 SPLITS GASSING TUBE

FLAT FILLING + GASSING TIP

Multi-Use - FILLING + GASSING NEEDLES



SS316L

Gassing + Filling Needle for  
Optima Inova Sterile Machines



SS316L

Gassing + Filling Needle for  
Rota Ampoules Machines



# GASSING NEEDLES

## MANUFACTURING EXCELLENCE

Developed for the best gas - nitrogen diffusion inside the pharmaceutical containers and made with thick material for longer lifetime and less possibilities of bent tubes. In some models the gassing tube has also the function of perfect centering of the filling tube. Aseptconn always use food & pharma regulations compliant material steelworks and manufacturers MOCA or FDA certified, ensuring maximum quality of products thanks to strict controls on raw materials. The final product must meet the highest quality standards monitored with appropriate measuring equipment. Products certifications include the tests reports carried out, quality and roughness reports.



Multi-Use - GASSING NEEDLES



SS316L

Nitrogen Gassing Needle for  
MAR Vials Machines



SS316L

Nitrogen Gassing Needle for  
Marchesini Ampoules Machines



Multi-Use - GASSING NEEDLES



SS316L

Nitrogen Gassing Needle for Rota  
Ampoules Machines



SS316L

Groninger Nitrogen Gassing  
Needle for Aseptic Machines



---

## Multi-Use - GASSING NEEDLES



SS316L

Nitrogen Gassing Needle for  
B+S Syringe Machines



SS316L

Nitrogen Gassing Needle for  
B+S Vials Machines



---

## Multi-Use - GASSING NEEDLES



SS316L

Nitrogen Gassing Needle for  
Syntegon Bosch Ampoules Machines



SS316L

Nitrogen Gassing Filling Needle  
for Syntegon Bosch Vials Machines



# NEEDLE SELECTION

## MANUFACTURING EXCELLENCE

### HIGH-QUALITY GASSING NEEDLES: EFFICIENCY AND PRECISION IN PHARMA AND BIOTECH PROCESSES

The world of pharmacy and biotechnology demands precision, reliability, and safety at every stage of production. A crucial component that plays a decisive role in this context is gassing needles. These small yet significant tools ensure the even distribution of gases and sterile fluids in a process that requires the highest standards of hygiene and quality. We will explain how gassing needles are used in the industry, what distinguishes high-quality needles, and what criteria you should consider when making a purchase.

\* The significance of gassing needles in these industries cannot be overstated, as they form the foundation for hygienic and efficient processes.



## CHARACTERISTICS OF HIGH-QUALITY GASSING NEEDLES AND SELECTION CRITERIA OF PURCHASE

### Definition and Industrial Applications of Gassing Needles

Gassing needles are specialized instruments used in a variety of industrial applications. Their primary purpose is to introduce gases or sterile fluids uniformly into a process to ensure sterility and control. The key application areas include:

**Pharmaceutical Production:** In the manufacturing of medicines and vaccines, gassing needles are essential to ensure reliable sterilization and homogenization of liquids.

**Food and Beverage Industry:** The production of food often requires the control of gases such as nitrogen to ensure product quality and durability.

When selecting gassing needles, there are specific features to keep in mind that distinguish high-quality needles from others. The key criteria include:

**Material Quality:** High-quality gassing needles are made of corrosion-resistant materials such as stainless steel or peek (polyetheretherketone). This ensures long-lasting durability and sterility.

**Precise Design:** The needle should be designed to ensure the uniform distribution of gas or fluid, preventing hotspots.

**Compatibility:** We ensure that the needle is compatible with your specific application and existing equipment.

**Certifications:** We check if the gassing needles comply with international standards and certifications for sterilization and quality.

**Consultation and Support:** Aseptconn is a reliable manufacturer that provides expert guidance and customer support to ensure you make the right choice.

At Aseptconn, we offer gassing needles that meet all of these criteria and are available in various sizes and configurations. Our experts are available to assist you in selecting the appropriate needles for your specific application.

# WASHING NEEDLES

## MANUFACTURING EXCELLENCE

Aseptconn washing needles are developed to optimize the washing performance with strong and durable tubes and tips. Aseptconn washing needles are possible to install in the main brands of machines and we can optimize the washing efficiency with a significative WFI use reduction with our special tips. For your machine we recommend a sufficient number of needles to ensure the smooth washing operations.



## Multi-Use - WASHING NEEDLES



SS316L

Washing Needle for B+S  
Machines



### Washing Needles Tips

Aseptconn developed strong and durable tubes and tips for high pressure washing needles for the best cleaning performance.



MULTI-HOLE  
WASHING TIP

## Multi-Use - WASHING NEEDLES



SS316L

Multi-Outlet Rinsing Needle  
for Dara Pharma Machines



SS316L

High Pressure Washing Needle  
for Dara Pharma Machines



Multi-Use - WASHING NEEDLES



SS316L

Washing Needle for IMA Farmomac  
Vials Machines



SS316L

Washing Needle for Marchesini  
Machines



Multi-Use - WASHING NEEDLES



SS316L

Turbo Washing Needle for Steriline  
SFM Machines



TURBO  
WASHING TIP

## Multi-Use - WASHING NEEDLES



SS316L

Washing Needle for Rota  
Machines



SS316L

Rinsing Needle for Syntegon Bosch  
Machines



## Multi-Use - WASHING NEEDLES



SS316L

Multi-Outlets Washing Needle for  
Syntegon Bosch Vials Machines



MULTI-HOLE  
WASHING TIP

# BLOWING & SUCTION NEEDLES

## MANUFACTURING EXCELLENCE

Blowing needles are mainly designed for Blow-Fill-Seal machines or to reduce drastically the drying operations of pre-washed vials or other pharmaceutical containers. Suction needles are special type of needles designed to adjust the correct height of the needle tip in relation of the liquid level for the best suction performance and precise regulation. Their RA < 0.5  $\mu\text{m}$  guarantees maximum sterilisation and hygiene standards, respect for good manufacturing processes: GMP, passivated and decontaminated. They are laser marked with permanent identification and complete traciability of lot number



## Multi-Use - BLOWING NEEDLES



SS316L

Blowing Needle for B+S  
Machines



SS316L

Blowing Needle with Special Tip for  
Dara Pharma Machines



## Multi-Use - SUCTION NEEDLES



SS316L

Suction Needle for Syntegon Bosch  
Machines



MULTI-CUTS  
BLOWING TIP

//  
WE ARE DRIVEN BY EXPERTISE  
THAT DELIVER  
HIGH QUALITY PRODUCTS  
//

# CRITICAL APPLICATIONS FOR STERILE AND ASEPTIC PROCESSES

## Stopper Guide Tubes

Aseptconn stopper guide tubes are for syringes made in one single piece. The stopper guide tubes have a high quality finishing with an internal surface finishing of  $RA < 0.2 \mu m$  and ultra polished surface. Our stopper guide tubes are custom-made to measure and made of corrosion-resistant materials such as 316L stainless steel with the possibility of hardening the steel up to 74 HRC.

### **Pharmaceutical Production:**

In the manufacturing of medicines and vaccines, stopper guide tubes are essential instruments to ensure reliable stoppering operations.

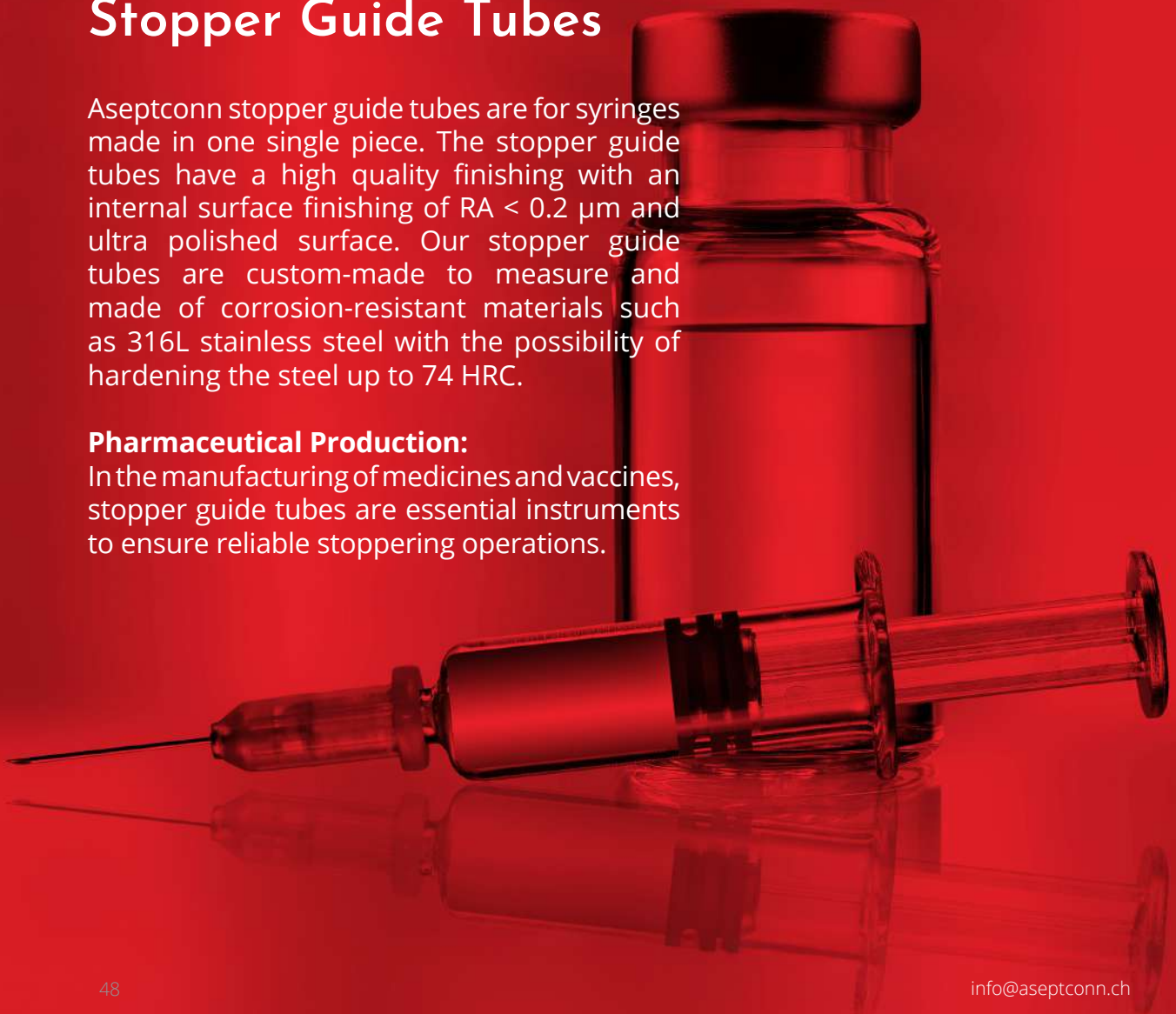



# STOPPER GUIDE TUBES

## MANUFACTURING EXCELLENCE

### CHARACTERISTICS OF HIGH-QUALITY STOPPER GUIDE TUBES

When selecting stopper guide tubes, there are specific features to keep in mind that distinguish high-quality syringes stopper tubes from others. The key criteria include:

**Precise Design:** Aseptconn offers a comprehensive service, support, and technical advice from design to final installation. We can deliver custom-made designs; our design engineers will support you with the first step in inventorying the process correctly to meet your needs and requirements.

**Manufacturing Excellence:** High-quality stopper guide tubes are made in respect for good manufacturing processes: GMP, this ensures long-lasting durability and sterility. Their internal surface finishing of  $RA < 0.2 \mu m$  and polished surface guarantees maximum sterilisation and hygiene standards. They are laser marked with permanent identification and complete traceability of lot number.

## Multi-Use - STOPPER GUIDE TUBES



SS316L

Syringe Stopper Guide Tube For  
B+S Sterile Machines



SS316L

Syringes Stopper Guide Tube for  
TruKing Filling Machines

---

Multi-Use - STOPPER GUIDE TUBES



SS316L

Syringes Stopper Guide Tube for  
Syntegon Bosch Aseptic Machines



SS316L

Syringes Stopper Guide Tube for  
Marchesini Filling Machines

---

Multi-Use - STOPPER GUIDE TUBES



SS316L

Syringes Stopper Guide Tube for  
Dara Pharma Filling Machines



SS316L

Syringes Stopper Guide Tube for  
Groninger Filling Machines



# CONNECTIONS

## MANUFACTURING EXCELLENCE

Connections are specialized parts used in a variety of industrial applications. These components are custom-made to measure and developed by our skilled designers to fit the customers requirements. Made from 316L stainless steel and supplied with the complete 3.1 certification according to EN 10204. Aseptconn always use food & pharma regulations compliant material steelworks and manufacturers MOCA or FDA certified, ensuring maximum quality of products thanks to strict controls on raw materials. The final product must meet the highest quality standards monitored with appropriate measuring equipment. We ensure that our components are compatible with your specific application and existing equipment.

---

## Components - CONNECTIONS



SS316L

PTFE Hoses Connection - Reducer for Bosch Syntegon Filling Machines

---



SS316L

Pharmaceutical Silicone Hose Connection - Reducer for MAR Filling Machines

---

## Components - CONNECTIONS



SS316L

Pharmaceutical Connection for Optima Inova Dosing Pumps

---



SS316L

Pharmaceutical Silicone Hose Connection for B+S Filling Machines

---

---

## Components - CONNECTIONS



SS316L

Pharmaceutical Connection for Groninger  
Dosing Pump



SS316L

Pharmaceutical Connection for Truiking  
Dosing Pump

---

## Components - CONNECTIONS



SS316L

Pharmaceutical Silicone Hose Connection -  
Reducer for MAR Filling Machines



SS316L

Pharmaceutical Connection for IMA  
Farmomac Dosing Machines

# MANIFOLDS & TANKS

## MANUFACTURING EXCELLENCE

The world of pharmacy and biotechnology demands precision, reliability, and safety at every stage of production. A crucial component that plays a decisive role in this context are tanks and manifolds. They are significant tools ensure the distribution of sterile fluids in a process that requires the highest standards of hygiene and quality. Manifolds and Tanks are specialized instruments for dosing systems used in a variety of pharma applications. Their primary purpose is to introduce sterile fluids uniformly into a process to ensure sterility and control. They are custom-made to measure and developed by our skilled designers to fit the customers requirements.

## Manifolds & Tanks - MANIFOLDS



SS316L

Manifold with Silicone Hoses Connections  
for Steriline SFM Aseptic Machines

---

## Manifolds & Tanks - MANIFOLDS

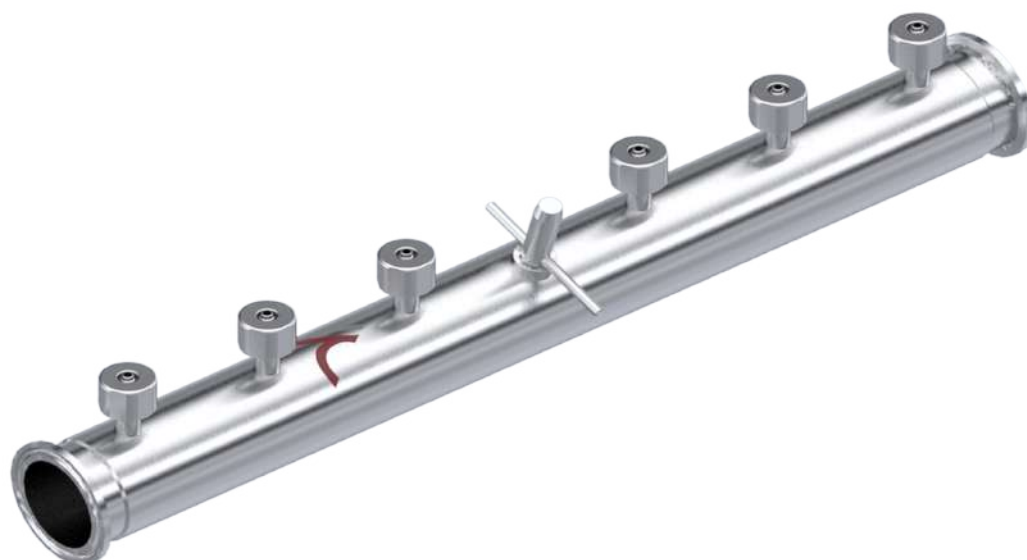

SS316L

Manifold with PTFE Hoses Connections for Syntegon Bosch Aseptic Machines

---



---

## Manifolds & Tanks - MANIFOLDS



SS316L

Pharmaceutical Manifold with Clamp Connections for Truiking Aseptic Machines

---

---

## Manifolds & Tanks - MANIFOLDS

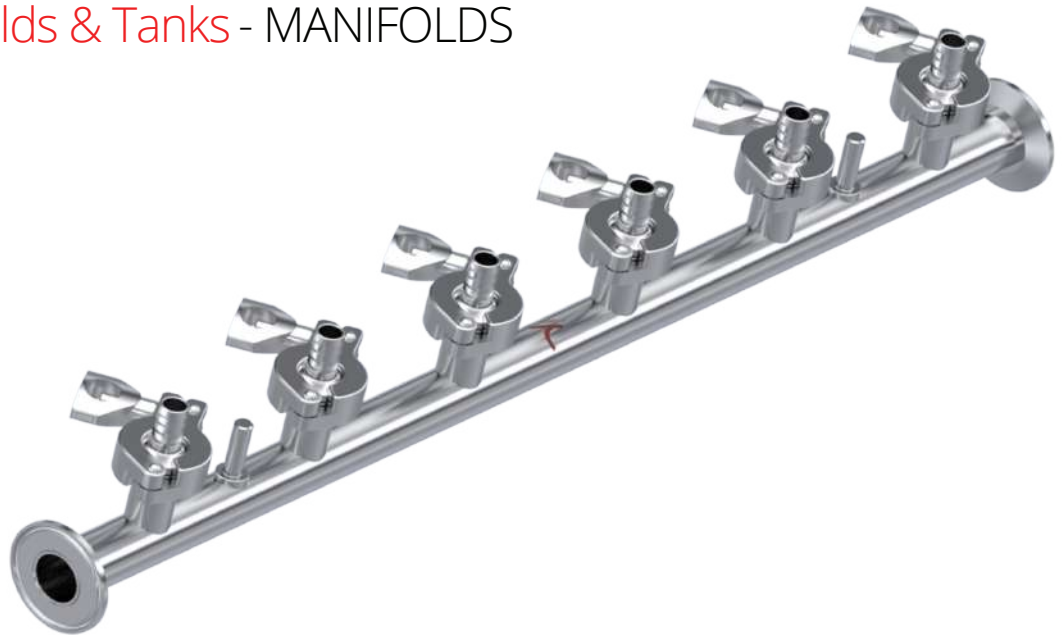

SS316L

Pharmaceutical Manifold for IMA  
Farmomac Aseptic Machines

---

---

## Manifolds & Tanks - MANIFOLDS



SS316L

Pharmaceutical Liquids Manifold for Optima  
Inova Sterile Machines

---



---

## Manifolds & Tanks - MANIFOLDS



SS316L

Manifold with Interchangeable Outlets  
for Groninger Machines

---

---

## Manifolds & Tanks - MANIFOLDS



SS316L

Pharmaceutical Liquids Manifold for B+S  
Aseptic Machines

---

---

## Manifolds & Tanks - TANKS



SS316L

Pharmaceutical Liquid Tank for Rota  
Sterile Ampoules Machines

---

---

## Manifolds & Tanks - TANKS



SS316L

Pharmaceutical Liquid Tank for  
Groninger Sterile Filling Machines

---

---

Manifolds & Tanks - TANKS

SS316L

Pharmaceutical Liquid Tank for  
Syntegon Bosch Sterile Vials Machines

---



---

Manifolds & Tanks - TANKS

SS316L

Pharmaceutical Liquid Tank for B+S  
Sterile Machines

---



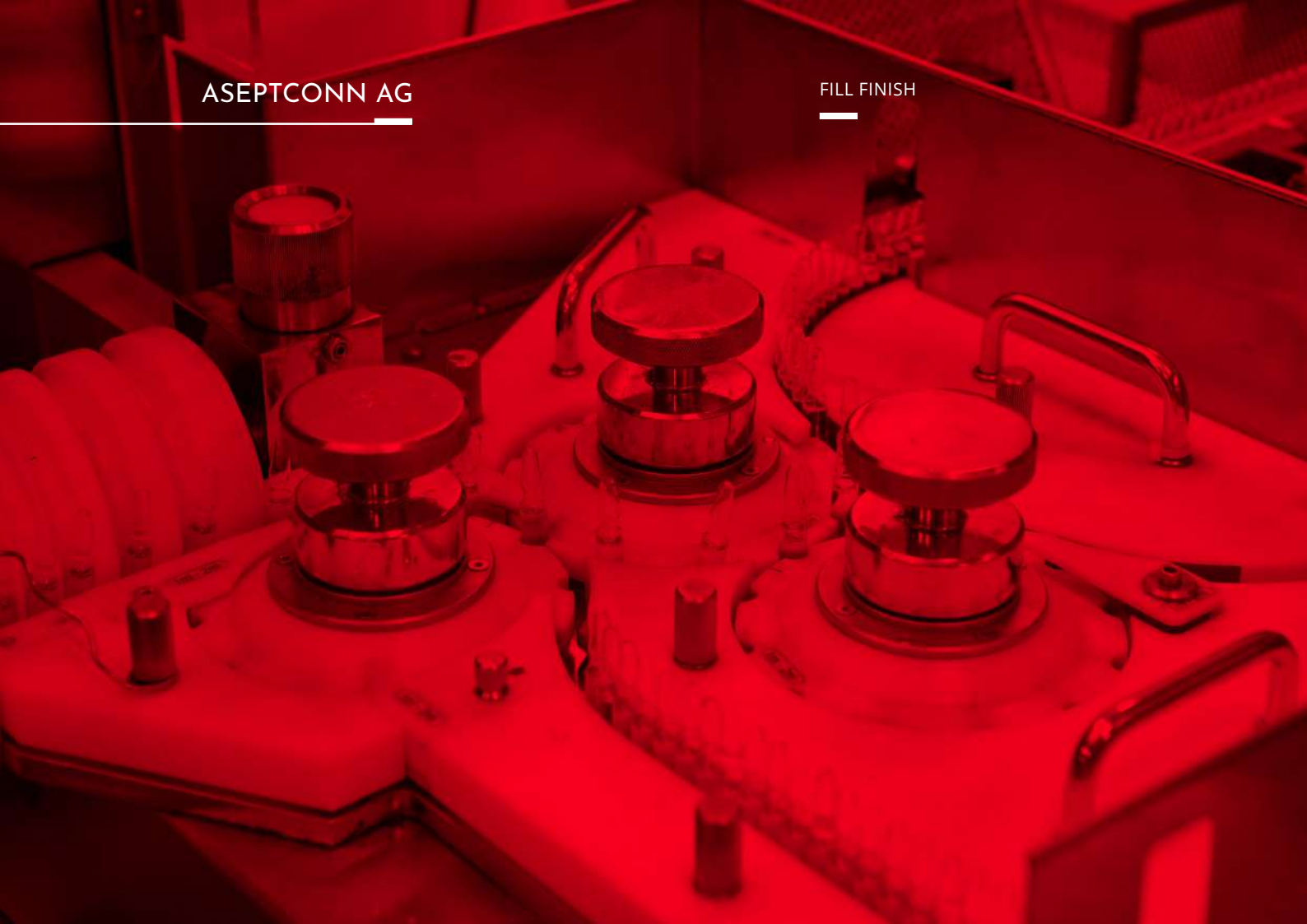

## FORMAT PARTS

### MANUFACTURING EXCELLENCE

Our Format Parts are for all pharmaceutical machines to handle ampoules and vials. These components are custom-made to measure and developed by our skilled designers to fit our customers requirements. We ensure that our components are compatible with your specific application and existing equipment.

#### POM-C PLASTIC

Plastic Format Spare Parts for Marchesini Vials Machines



# FORMAT PARTS FOR STERILE AND ASEPTIC PROCESSES



SS316L

Format Part for Blister Packing  
Machines

---

Format Parts - FORMATS



SS316L

Nest Format Part for IMA  
Pharmaceutical Syringes Machines

---

---

Format Parts - FORMATS



SS316L & TIN COATING

Format Part Mould for Suppositories  
Filling Machines

---

---

Format Parts - FORMATS



SS316L

Format Part for Marchesini  
Ampoules Machines

---

---

Format Parts - FORMATS



SS316L & POM-C

Format Parts for Groninger  
Vials Machines

---

---

Format Parts - FORMATS



POM-C PLASTIC

Plastic Format Part for Syntegon  
Bosch Vials Machines

---

---

Format Parts - FORMATS

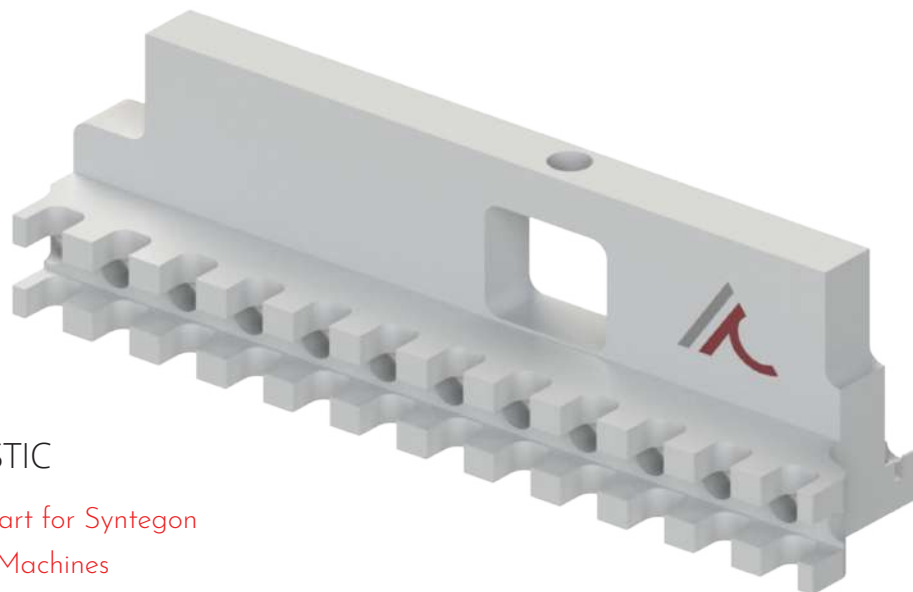

POM-C PLASTIC

Plastic format Part for Syntegon  
Bosch Syringes Machines

---



---

## Format Parts - FORMATS

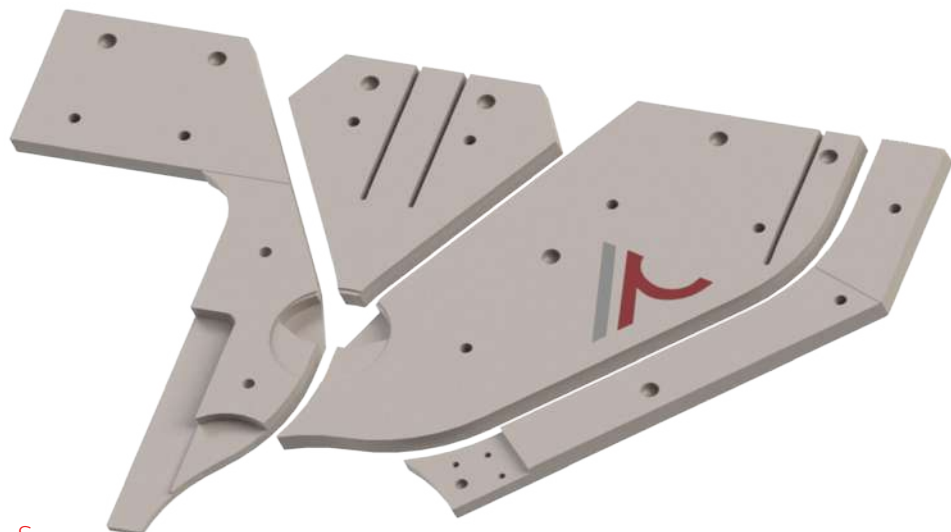

PEEK PLASTIC

Peek Format Part for B+S  
Vials Machines

---

---

## Format Parts - FORMATS



POM-C PLASTIC

Plastic Format Part for Dara  
Pharma Vials Machines

---

---

Format Parts - PLASTIC SCREWS



POM-C PLASTIC

Plastic Screw Conveyor for Groninger  
Vials Filling Machines

---

---

Format Parts - PLASTIC SCREWS



POM-C PLASTIC

Plastic Screw Conveyor for B+S  
Vials Filling Machines

---

---

Format Parts - PLASTIC SCREWS

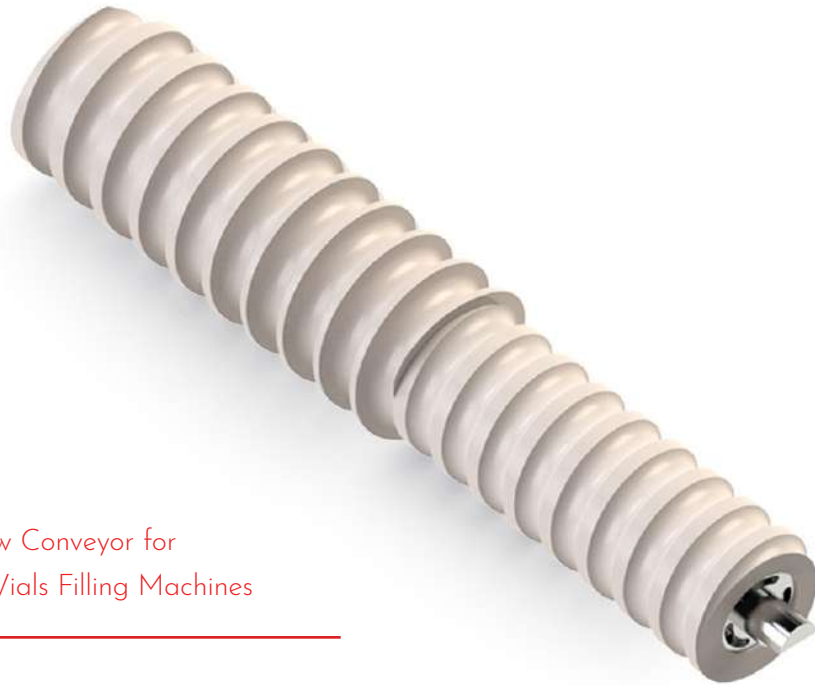

PEEK

Peek Plastic Screw Conveyor for  
Syntegon Bosch Vials Filling Machines

---

---

Format Parts - PLASTIC SCREWS



POM-C PLASTIC

Plastic Screw Conveyor for IMA  
Sterile Filling Machines

---

Spare Parts - ACCESSORIES



SS316

Filling Needles Holder for Syntegon Bosch  
Pharmaceutical Machines

Spare Parts - Accessories



SS316L

Pharmaceutical Comb Tool for Vials Setup

---

Spare Parts - ACCESSORIES

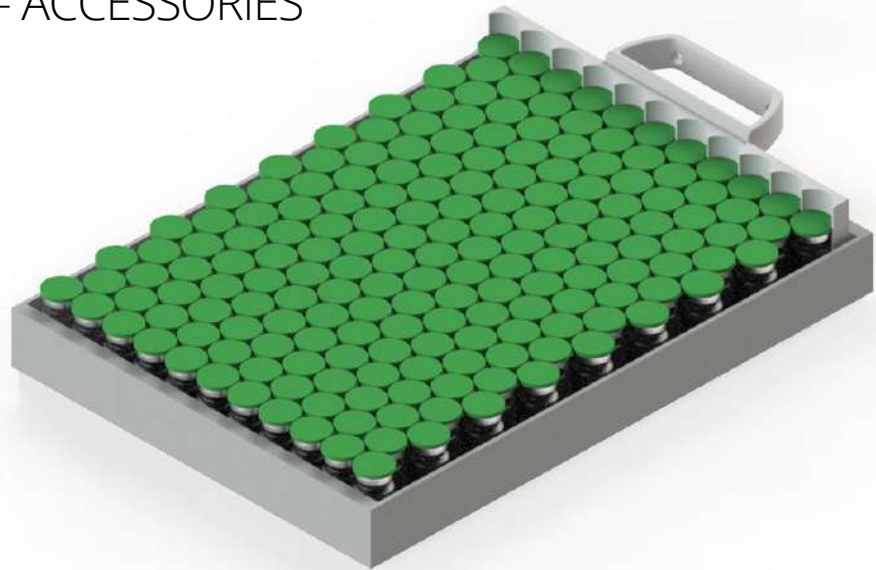

POM-C PLASTIC

Alignment Tool for Pharmaceutical  
Vials Machines

---

Spare Parts - ACCESSORIES



PEEK

Autoclavable Peek Holder for Filling  
Needles Sterilization

# ORDER PROCESS

## CONNECT WITH ASEPTCONN



### Expert Support & Service

A quick and efficient response on customers request with our high expertise of fill-finish components we can find customized solutions to our customers requirements and needs. After our advise we can provide the best offer. We support our customers and provide them with the service they need.



### Manufacturing processes

Further follow up with an order confirmation and the manufacturing of high-quality components in line with respect for good manufacturing processes: GMP, this ensures long-lasting durability and sterility. They are laser marked with permanent identification and complete traciability of lot number.



### Fast and Reliable Services

Our responses and deliveries are fast and reliable. Complete documentations are provided that includes: complete 3.1 certification, declaration of conformity of materials, decontaminations and passivation certification. After sales services are highly valued. We maintain friendly contact with our customers.



# YOUR CONTACTS

CONNECT WITH ASEPTCONN

**Your one Stop Shop for  
the Pharmaceutical  
and Biopharmaceutical  
Industries**



Scan the QR Code  
or visit our  
Homepage  
[www.aseptconn.ch](http://www.aseptconn.ch)

.....

In case of any questions, we will be happy to advise you. We also like to present our products to you in your company.

**Please get in contact with us!**

## **Fabio Stiz**

**CEO / co-founder**

 +41 52 725 10 12

 +41 79 440 89 66 (Mobile)

 [fabio.stiz@aseptconn.ch](mailto:fabio.stiz@aseptconn.ch)

## **Sergio Cerenzia**

**COO / co-founder**

**Dipl. Ing. FH**

 +41 52 725 10 13

 +41 76 568 54 12 (Mobile)

 [sergio.cerenzia@aseptconn.ch](mailto:sergio.cerenzia@aseptconn.ch)

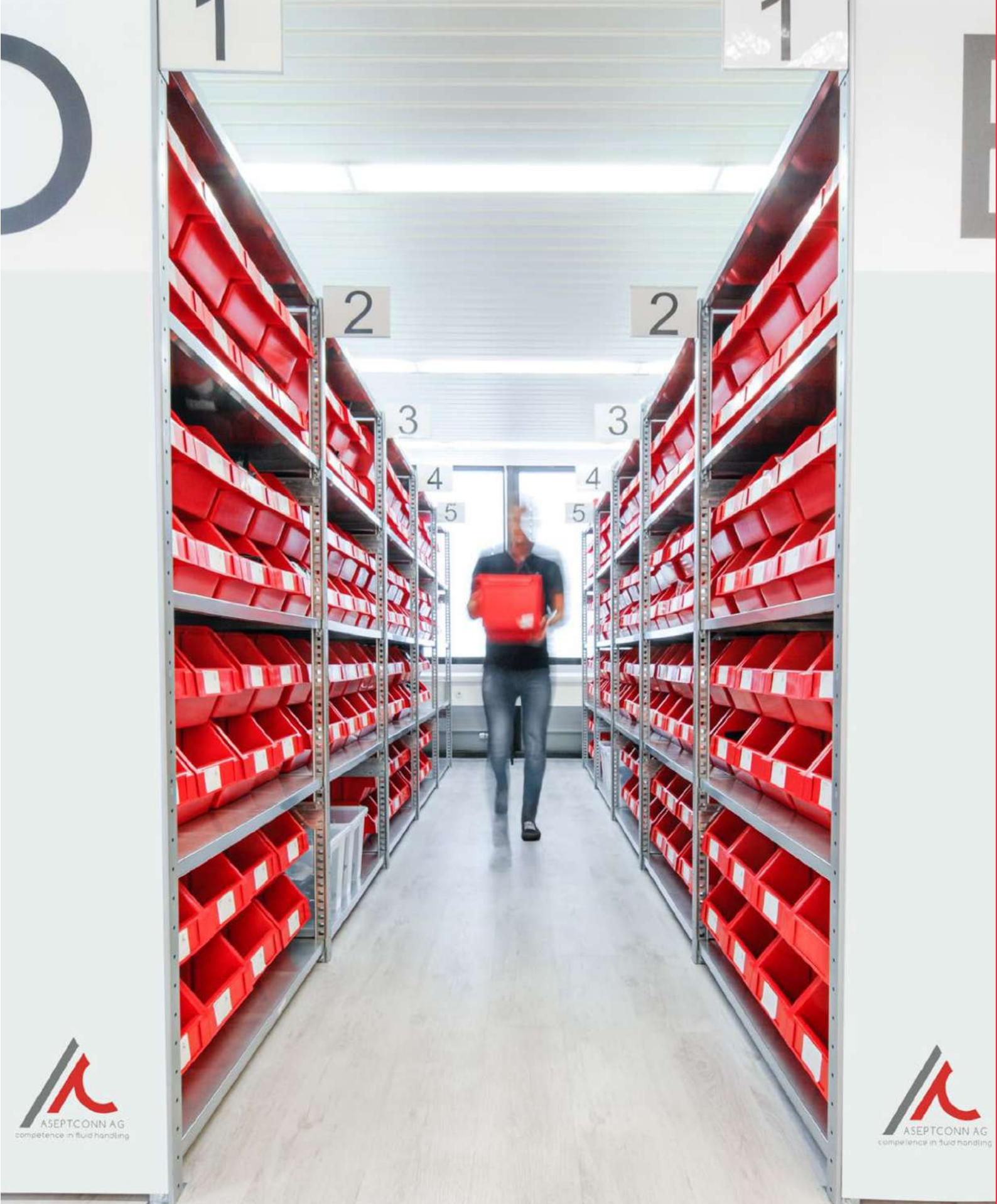



# CONNECT WITH ASEPTCONN

## ASEPTCONN AG

### **HEAD OFFICE**

Moosmattstrasse 24  
CH-8953 Dietikon

#### ***Phone***

+41 52 725 10 10

### **MANUFACTURING OFFICE**

Rue de l'Industrie 18  
CH-1630 Bulle

#### ***Phone***

+41 52 725 10 10

#### ***Email***

[info@aseptconn.ch](mailto:info@aseptconn.ch)

#### ***Website***

[www.aseptconn.ch](http://www.aseptconn.ch)